

0070-24219-BNC



# Surveillance Monitor

## USER MANUAL



- Please read this manual carefully before operating your set.
- Retain it for future reference.
- Record model number and serial number of the set.
- See the label attached on the back cover and quote this information to your dealer when you require service.

The terms HDMI, HDMI High-Definition Multimedia Interface, HDMI trade dress and the HDMI Logos are trademarks or registered trademarks of HDMI Licensing Administrator, Inc.



**NOTE:** There is a problem in VGA mode. (Only VGA mode applied)

PROBLEM	POSSIBLE SOLUTION
The signal is out of range	-Adjust resolution, horizontal frequency, or vertical frequency. -Check it whether the signal cable is connected or loose. -Check the input source.
Vertical bar or stripe on back ground & Horizontal Noise & Incorrect position	-Work the auto configure or adjust clock, phase, or H/V position.
Screen color is unstable or single color	-Check the signal cable. -Reinstall the PC video card.

**4. Maintenance**

Early manifications can be prevented. Careful and regular cleaning can extend the amount of time in that way, you will have a new one. Be sure to turn the power off and unplug the power cord before you begin any cleaning.

**Cleaning the screen**

Here's a great way to keep the dust off screen for a while. Wet soft cloth in a mixture of lukewarm water and a little fabric softener or dish washing detergent. Wring the cloth until it's almost dry, and then used it to wipe the screen.

Make sure the remained water is off the screen, and then let it air-dry before you turn on your monitor.

**Cleaning the cabinet**

To remove dirt or dust, wipe the cabinet with a soft, dry, lint-free cloth. Please be sure not to use a wet cloth.

**Extended Absence**

 If you anticipate to store the monitor for extended periods of time or otherwise not turning the monitor on, disconnect the monitors power cable.

**TABLE OF CONTENTS** ... 1

**WARNING** ..... 2

**SAFETY INSTRUCTIONS** ..... 3

**1. INTRODUCTION** ..... 5

**1.1 CONTROLS** ... 5

**1.2 ACCESSORIES**..... 5

**1.3 CONNECTION OPITONS**..... 6

**1.4 REMOTE CONTROL KEY FUNCTIONS**..... 7

**1.5 INSTALLING BATTERIES**..... 8

**1.6 EXTERNAL EQUIPMENT CONNECTIONS** ... 8

**2. BASIC OSD SETUP** ..... 10

**3. TROUBLE SHOOTING** ... 15

**4. MAINTANCE** ... 16

**WARNING**





**CAUTION**

RISK OF ELECTRIC SHOCK  
DO NOT OPEN



**WARNING**  
TO REDUCE THE RISK OF ELECTRIC SHOCK DO NOT REMOVE COVER (OR BACK). NO USER SERVICEABLE PARTS INSIDE. REFER TO QUALIFIED SERVICE PERSONNEL.

 The lightning flash with arrowhead symbol, within an equilateral triangle, is intended to alert the user to the presence of uninsulated “dangerous voltage” within the products enclosure that may be of sufficient magnitude to constitute a risk of electric shock to persons.

 The exclamation point within an equilateral triangle is intended to alert the user to the presence of important operating and maintenance (servicing) instructions accompanying the appliance.

**REGULATORY INFORMATION**

This equipment generates, uses and can radiate radio frequency energy and, if not installed and used in accordance with the instructions, it may cause harmful interference to radio communications however, there is no guarantee that interference will not occur in a particular installation. If this equipment does cause harmful interference to radio or television reception, which can be determined by turning the equipment off and on, the user is encouraged to try to correct the interference by one or more of the following measures:

- Increase the separation between the equipment and receiver.
- Connect the equipment into an outlet on a circuit different from that to which the receiver is connected.
- Consult the dealer or experienced radio/monitor technician for help.

Any changes or modifications not expressly approved by the party responsible for compliance could void the users authority to operate the equipment.

**CAUTION**

Do not attempt to modify this product in any way without authorization from Ernitec Technical Support. Unauthorized modification will void the products warranty.

**3.Trouble shooting**

**Before connect the service technology, perform the following simple checks. If any problem still exist, unplug the CCTV monitor and calling for serving.**

PROBLEM	POSSIBLE SOLUTION
No sound picture	-Check that the main plug has been connected to a wall let. -Check that you have pressed the POWER button on the front of monitor set. -Check the picture contrast and brightness settings.
Normal picture but no sound	-Check the volume. -Sound muted? Press the MUTE button. -Try another channel the problem may be with the broadcast. -Are the audio cables installed properly.
The remote control does not work	-Check go see if there any object between the product and remote control -Causing obstruction. -Are batteries installed with correct polarity(+to+, -to-). -Correct remote operating mode set: MONITOR, VCR etc.? -Install new batteries.
Power is suddenly turned off	-Is the sleep times set. -Check the power control settings. Power interrupted. -No broadcast on station tuned with auto activated.
Picture appears slowly after switching on	-This is normal, the image is muted during the product startup process. Please contact your service center, if the picture has not appeared after five minutes.
No or poor color or poor picture	-Adjust the color in menu option. -Keep a sufficient distance between the product and the VCR. -Try another channel, the problem may be with the broadcast. -Are the VIDEO cables installed properly? -Activate the any function to restore the brightness of the picture.
Horizontal/vertical bars or picture shaking	-Check for local interference such as an electrical appliance or power tool.
No output from one of the speakers	-Adjust balance in menu option.

### 2.5.3 “Sound” Menu Option

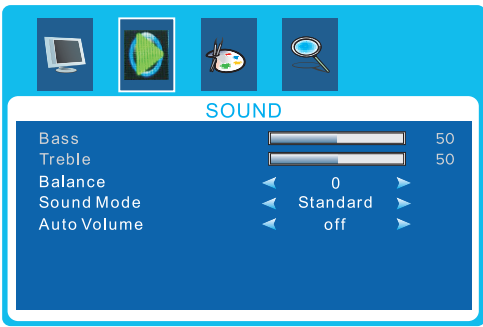

- Press “◀ ▶”button to select Sound menu.
- Use “▼▲” to select what you want to adjust on Mode
- Press “◀ ▶”button to adjust “Balance” “Sound Mode” “Auto Volume”
- When you are satisfied with your adjustment, press MENU to exit the main menu.

### 2.5.4 “OPTION” and “FUNCTION” Menu Option

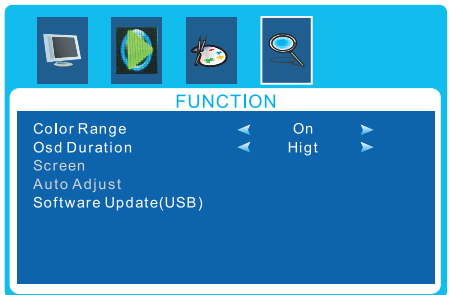
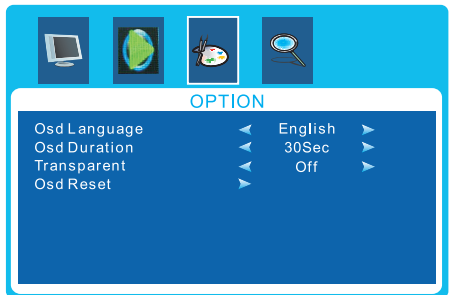







- Press “◀ ▶”button to select OPTION or FUNCTION menu.
- Use “▼▲” to select what you want to adjust on Mode
- Press “◀ ▶”button to adjust “OSD Language” “OSD Reset” “Software Update” etc
- When you are satisfied with your adjustment, press MENU to exit the main menu.

### Safety instructions

**WARNING:**  
To reduce the risk of fire or electric shock, do not expose this apparatus to rain or moisture.

Apparatus shall not be exposed to dripping or splashing area. An objects filled with liquids such as vases shall not be placed on the apparatus.

#### IMPORTANT SAFETY INSTRUCTIONS

<p>Read these instructions and keep them for future reference.</p> 	<p>Do not install the monitor near any significant sources of heat.</p> 
<p>Do not use the monitor near water.</p> 	<p>Disconnect power if the monitor will not be used for long periods of time.</p> 
<p>Clean the cabinet only with a dry cloth.</p> 	<p>Ensure all cables are properly stowed and not pinched anywhere.</p> 
<p>Provide adequate ventilation around the proximity of the monitor.</p> 	<p>Only use attachments and accessories specified by Ernitec.</p>

## SAFETY INSTRUCTIONS

When the unit requires repairs, please contact your vendor or Ernitec Technical Support.

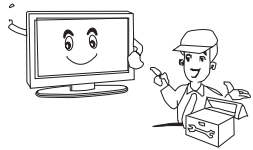

- The monitor may "flicker" momentarily when turned on while cold. This is normal.
- Pixel errors in the form of tiny red, green or blue dots may appear on the screen, these do not adversely affect the monitors performance.

### On Disposal

Under the Directive 2012/19/EU on waste electrical and electronic equipment (WEEE), product(s) used electrical and electronic equipment (WEEE) should not be mixed with general household waste.

For proper treatment, recovery and recycling, please take this product(s) to designated collection points where it will be accepted free of charge.

Disposing of this product correctly will help save valuable resources and prevent any potential negative effects on human health and the environment, which could otherwise arise from inappropriate waste handling.

Please contact your local authority for further details of your nearest designated collection point. Penalties may be applicable for incorrect disposal of this waste, in accordance with your national legislation.

## Basic OSD setup

### 2.5.2 "Aspect Ratio" Menu Option

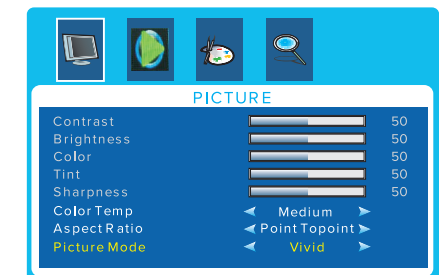
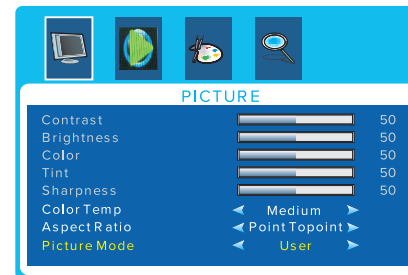
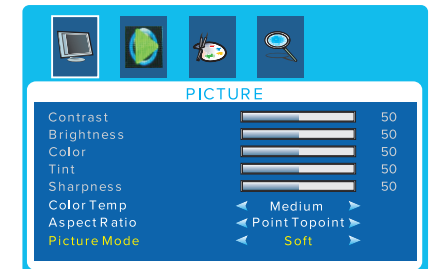
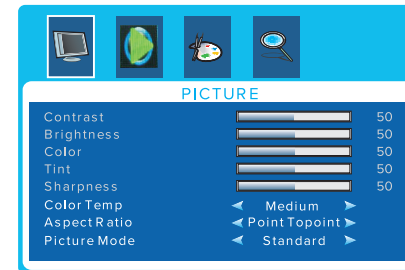

- Press "◀ ▶" button to select PICTURE menu.
- Use "▼▲" to select what you want to adjust on Picture Mode
- Press "◀ ▶" button to adjust "Point to Point" "Zom1" "Zom2" "Auto" "4:3", "Panorama"
- When you are satisfied with your adjustment, press MENU to exit the main menu.

## 2.5.2 “Aspect Ratio” Menu Option



- Press “ ◀ ▶ ”button to select PICTURE menu.
- Use “ ▼ ▲ ” to select what you want to adjust on Color Temp
- Press “ ◀ ▶ ”button to adjust “Point to Point” “Zom1” “Zom2” “Auto” “4:3”, “Panorama”
- When you are satisfied with your adjustment, press MENU to exit the main menu.

## 1.Introduction

### 1.1 Controls

-This is a simplified representations of front panel.

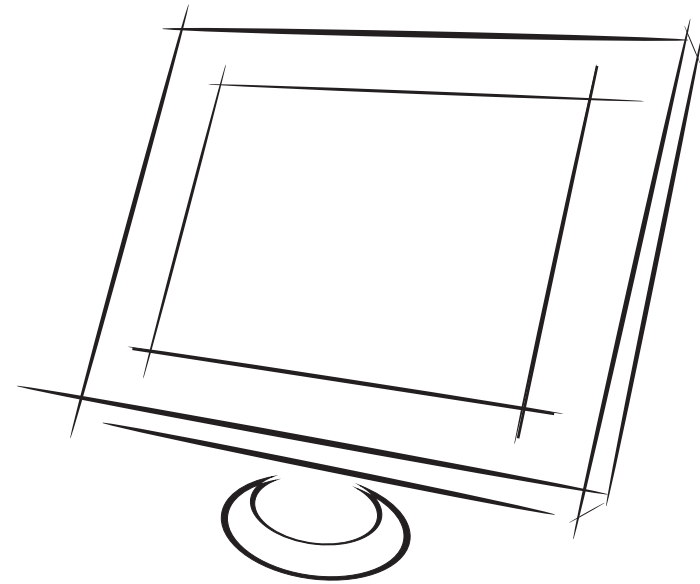

### 1.2 Accessories

Ensure that the following accessories are included with your CCTV monitor. If any accessory is missing, please contact the dealer from where you purchased the product.

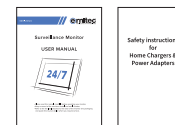

User manual  
Safety instructions

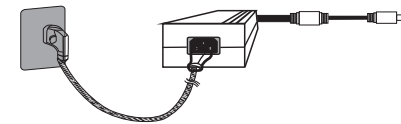

Power adapter



Remote control

1.3 Connection Options

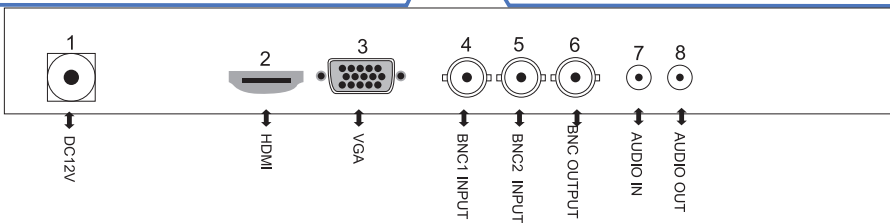
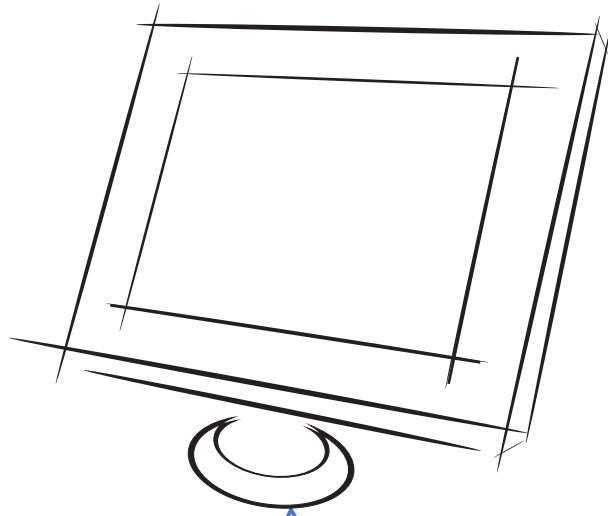

ITEM	BUTTON NAME	FUNCTION DESCRIPTION
1	POWER	DC input socket
2	HDMI	HDMI INPUT
3	VGA	VGA INPUT
4	BNC1 INPUT	Connect the BNC output jack of PROCESSOR
5	BNC2 INPUT	Connect the BNC output jack of PROCESSOR
6	BNC OUT	Connect the BNC input jack of other monitor
7	AUDIO 1	Audio input
8	AUIO2	Audio2 out

2.5. OSD setup under VGA/HDMI input mode.

- A. Press the “MENU” button to access Main Menu setting interface.
- B. Press the “◀ ▶” to select the desired submenu.
- C. Press the “▼ ▲” again to enter the submenu.

2.5.1 “Color Temp” Menu Option



- Press “◀ ▶”button to select PICTURE menu.
- Use “▼▲” to select what you want to adjust on Color Temp
- Press “◀ ▶”button to adjust “Medium” “Warm” “Cold” “User” .
- When you are satisfied with your adjustment, press MENU to exit the main menu.



## 2. Basic OSD setup

### 2.1 Turning on and off the CCTV monitor

#### 2.1.1 Turn on monitor

- Connect the AC input cable to monitor, then press the main power switch on monitor. At this time the monitor will enter into standby mode and the indicator light turn red.
- Using buttons can turn on monitor from standby mode as follows: Press POWER keyon front panel or on the remote control.

#### 2.1.2 Turn off monitor

- Press POWER button on front panel the or on the remote control to enter standby mode. The indicator light is red.
- Using main power switch turns off monitor completely.

### 2.2 Selecting screen language

**NOTE:** If you use your monitor for the first time, you should select the language which will be used for displaying menus and indications.

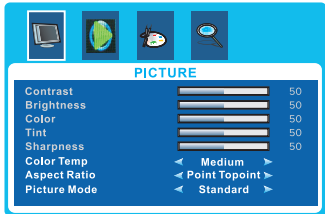

- Press the "MENU" button into main menu.
- Press the "◀▶" button to select OSD menu.
- Press the "▼▲" button to select OSD LANGUAGE.
- Press the "◀▶" button to select your language.
- When you are satisfied with your choice, press MENU to exit.

### 2.3 NO SIGNAL

There is NO SYNC menu on screen when there is no input signal.

**NO SIGNAL**

### 2.4 Selecting input source

VGA  
HDMI  
AV 1  
AV 2

You can select the input source by pressing INPUT button on the remote control on the front panel.

- Press the "▼▲" button to select the source you want.
- Press the "INPUT" button to confirm.

## 1.4 Remote Control Key Functions



**POWER** Switch on monitor when at standby mode or vice versa.

**MUTE** Press to mute the sound. Press again or press VOL+ to unmute.

▲  
▼  
▲  
▶  
**Menu selection.** ▼ ▲

▶  
**Press to increase / decrease**

**MENU** Press to bring up the main menu to the screen and exit the current menu.

**INPUT** Press to cycle through the input source in following:  
VGA BNC1 BNC2 HDMI YPBPR

**PICTURE** Press repeatedly to cycle through the available video picture

## 1.5 Installing Batteries

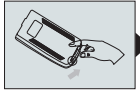

▶ Open the battery compartment cover on the the back side.

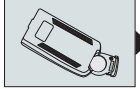

▶ Insert ONE CR2032 3V batteries in correct polarity .Do not mix old or used batteries with new ones.



▶ Close the cover.



▶ Point the remote towards the remote control sensor of the wireless monitor and use it within 7 meters.



▶ Put the used batteries into the recycling bin since it can negatively affect the environment.

## 1.6 External Equipment Connections

### 1.6.1 Power Cord Connection

Connect the power cord correctly as shown.  
Press the POWER switch of your CCTV monitor to switch on the CCTV monitor.  
The power indication on the front panel lights is green.

## 1.6.2 BNC INPUT and BNC OUTPUT Connection

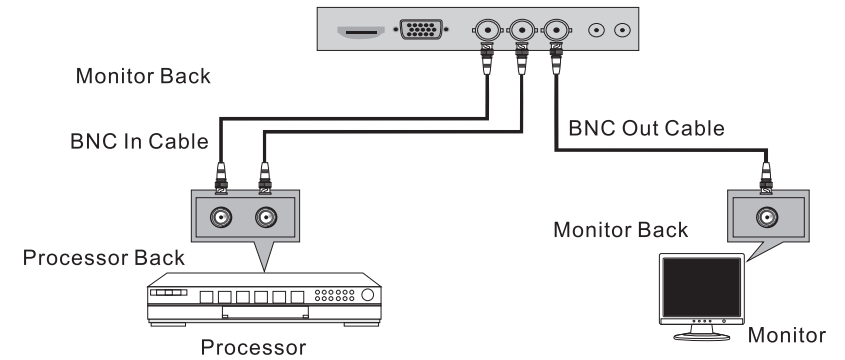

- Connect the BNC in cable output of the PROCESSOR to the BNC input on the set.
- Connect the BNC out cable input of the other monitor to the BNC output on the set.
- Select BNC1 or BNC2 input source with using the INPUT button on the remote control.

### 1.6.4 PC Connection

This CCTV monitor provides plug and play capability, meaning that the PC adjusts automatically to the monitor's setting. The CCTV monitor sends configuration information(EDID) to the PC using the Video Electronics Standard Association (VESA)Display Data Channel(DDC) protocol.

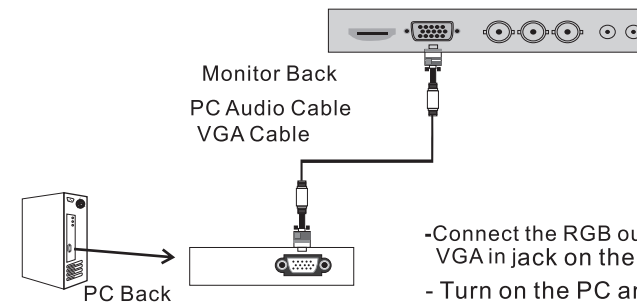

- Connect the RGB output of the PC to the VGA in jack on the set.
- Turn on the PC and set.
- Select the VGA input source with using INPUT button on the remote control.