

10" TVI Metal Frame

User Manual



- Please read this manual carefully before operating your set.
- Retain it for future reference.
- Record model number and serial number of the set.
- See the label attached on the back cover and quote this information to your dealer when you require service.

WARNING





CAUTION

RISK OF ELECTRIC SHOCK
DONOT OPEN



WARNING:
TO REDUCE THE RISK OF ELECTRIC SHOCK DO NOT REMOVE COVER(OR BACK). NO UESR SERVICEABLE PARTS INSIDE. REFER TO QUALIFIED SERVICE PERSONNEL.

 The lightning flash with arrowhead symbol, within an equilateral triangle, is intended to alert the user to the presence of uninsulated “dangerous voltage” within the products enclosure that may be of sufficient magnitude to constitute a risk of electric shock to persons.

 The exclamation point within an equilateral triangle is intended to alert the user to the presence of important operating and maintenance (servicing) instructions accompanying the appliance.

REGULATORY INFORMATION

This equipment generates, and can radiate eletromagnetic emissions (energy). If not installed and used in accordance with the instructions, it may cause harmful interference to radio communications however, there is no guarantee that interference will not occur in a particular installation. If this equipment does cause harmful interference to radio or television reception, which can be determined by turning the equipment off and on, the user is encouraged to try to correct the interference by one or more of the following measures:

- Increase the separation between the equipment and receiver.
- Connect the equipment into an outlet on a circuit different from that to which the receiver is connected.
- Consult the dealer or experienced radio/monitor technician for help.



CAUTION:

Do not attempt to modify this product in any way without written authorization from Ernitec Technical Support. Unauthorized modification could void the user's Warranty and in worst case be dangerous to persons, animals and property.



Informations importantes sur les DEEE

Ce symbole sur le produit ou les documents d'accompagnement signifie qu'en vertu de la directive 2012/19/UE relative aux déchets d'équipements électriques et électroniques (DEEE), le ou les produits d'équipements électriques et électroniques usagés (DEEE) ne doivent pas être mélangés avec les déchets ménagers ordinaires. Pour un traitement, une récupération et un recyclage appropriés, veuillez apporter ce produit à des points de collecte désignés où il sera accepté gratuitement. L'élimination correcte de ce produit contribuera à économiser des ressources précieuses et à prévenir tout effet négatif potentiel sur la santé humaine et l'environnement, qui pourrait autrement résulter d'une gestion inappropriée des déchets. Veuillez contacter votre autorité locale pour plus d'informations sur le point de collecte désigné le plus proche. Des pénalités peuvent s'appliquer en cas d'élimination incorrecte de ce déchet, conformément à votre législation nationale. Pour les utilisateurs professionnels dans l'Union européenne Si vous souhaitez mettre au rebut un équipement électrique et électronique (DEEE), veuillez contacter votre revendeur ou votre fournisseur pour plus d'informations.



apparecchiature elettriche ed elettroniche (RAEE)

Questo simbolo sul prodotto e/o sui documenti di accompagnamento indica che, ai sensi della Direttiva 2012/19/UE sui rifiuti di apparecchiature elettriche ed elettroniche (RAEE), i prodotti utilizzati non devono essere mischiati con i rifiuti domestici generici. Per un corretto smaltimento, recupero e riciclaggio, portare questi prodotti nei punti di raccolta designati dove saranno accettati gratuitamente. Lo smaltimento corretto di questo prodotto consentirà di risparmiare risorse preziose e di prevenire potenziali effetti negativi sulla salute umana e sull'ambiente, che potrebbero altrimenti derivare da una gestione inadeguata dei rifiuti. Contattare l'autorità locale per ulteriori dettagli sul punto di raccolta designato più vicino. In caso di smaltimento non corretto di questi rifiuti, possono essere applicate sanzioni in conformità alla legislazione nazionale. Per utenti professionali nell'Unione Europea Per lo smaltimento di apparecchiature elettriche ed elettroniche (AEE), contattare il rivenditore o il fornitore per ulteriori informazioni.



Información importante sobre RAEE

Este símbolo en el producto y/o en los documentos que lo acompañan indica que, en virtud de la Directiva 2012/19/UE sobre residuos de aparatos eléctricos y electrónicos (RAEE), el/los producto(s) usado(s) eléctrico(s) y electrónico(s) no debe(n) mezclarse con los residuos domésticos generales. Para un tratamiento, recuperación y reciclaje adecuados, lleve este producto a los puntos de recogida designados, donde lo aceptarán de forma gratuita. Al desechar estos productos correctamente, ayudará a ahorrar recursos valiosos y a evitar cualquier posible efecto negativo en la salud humana y el medioambiente que pudiera derivarse de una manipulación inadecuada de los residuos. Póngase en contacto con las autoridades locales para obtener más detalles sobre el punto de recogida designado que tenga más cerca. Pueden imponerse sanciones por desechar de forma incorrecta estos residuos, según la legislación de su país. Para usuarios profesionales de la Unión Europea: Si desea desechar equipos eléctricos y electrónicos (RAEE), póngase en contacto con su distribuidor o proveedor para obtener más información.



Vigtige oplysninger om affald fra elektrisk og elektronisk udstyr

Dette symbol på produktet og/eller de ledsagende dokumenter angiver, at i henhold til Rådets direktiv 2012/19/EU om affald af elektrisk og elektronisk udstyr (WEEE), må et brugt elektrisk og elektronisk produkt eller brugte elektriske og elektroniske produkter (WEEE) ikke sammenblandes med almindeligt husholdningsaffald. Du bedes aflevere dette produkt på de dertil indrettede indsamlingssteder, hvor det modtages uden beregning med henblik på korrekt behandling, genanvendelse og genbrug. Hvis du bortskaffer dette produkt korrekt, er du med til at bevare værdifulde ressourcer og forebygge potentielle negative virkninger på menneskers helbred og miljøet, som ellers kunne opstå som følge af u hensigtsmæssig affaldshåndtering. Kontakt de lokale myndigheder eller for at få yderligere oplysninger om dit nærmeste dertil indrettede indsamlingssted. Der kan blive pålagt bøder for ukorrekt bortskaffelse af dette affald i overensstemmelse med den nationale lovgivning, der er gældende i dit land. Til professionelle brugere i Den Europæiske Union Hvis du ønsker at kassere elektrisk og elektronisk udstyr (WEEE), bedes du kontakte din forhandler eller leverandør for at få yderligere oplysninger.



Important WEEE information

This symbol on the product and /or accompanying documents indicates that, under Directive 2012/19/EU on waste electrical and electronic equipment (WEEE), product(s) used electrical and electronic equipment (WEEE) should not be mixed with general household waste.

For proper treatment, recovery, and recycling, please take this product to designated collection points where it will be accepted free of charge.

Disposing of this product correctly will help save valuable resources and prevent any potential negative effects on human health and the environment, which could otherwise arise from inappropriate waste handling.

Please contact your local authority or for further details of your nearest designated collection point.

Penalties may be applicable for incorrect disposal of this waste, in accordance with your national legislation.

For professional users in the European Union

If you wish to discard electrical and electronic equipment (WEEE), please contact your dealer or supplier for further information.



Wichtige WEEE-Informationen Getrennte Erfassung von Altgeräten

Elektro- und Elektronikgeräte, die zu Abfall geworden sind, werden als Altgeräte bezeichnet. Besitzer von Altgeräten haben diese einer vom unsortierten Siedlungsabfall getrennten Erfassung zuzuführen. Altgeräte gehören insbesondere nicht in den Hausmüll, sondern in spezielle Sammel- und Rückgabesysteme.

Batterien und Akkus sowie Lampen

Besitzer von Altgeräten haben Altbatterien und Altkumulatoren, die nicht vom Altgerät umschlossen sind, sowie Lampen, die zerstörungsfrei aus dem Altgerät entnommen werden können, im Regelfall vor der Abgabe an einer Erfassungsstelle vom Altgerät zu trennen. Dies gilt nicht, soweit Altgeräte einer Vorbereitung zur Wiederverwendung unter Beteiligung eines öffentlich-rechtlichen Entsorgungsträgers zugeführt werden.

Möglichkeiten der Rückgabe von Altgeräten

Besitzer von Altgeräten aus privaten Haushalten können diese bei den Sammelstellen der öffentlich-rechtlichen Entsorgungsträger oder bei den von Herstellern oder Vertreibern im Sinne des ElektroG eingerichteten Rücknahmestellen unentgeltlich abgeben. Rücknahmepflichtig sind Geschäfte mit einer Verkaufsfläche von mindestens 400 m² für Elektro- und Elektronikgeräte sowie diejenigen Lebensmittelgeschäfte mit einer Gesamtverkaufsfläche von mindestens 800 m², die mehrmals pro Jahr oder dauerhaft Elektro- und Elektronikgeräte anbieten und auf dem Markt bereitstellen. Dies gilt auch bei Vertrieb unter Verwendung von Fernkommunikationsmitteln, wenn die Lager- und Versandflächen für Elektro- und Elektronikgeräte mindestens 400 m² betragen oder die gesamten Lager- und Versandflächen mindestens 800 m² betragen. Vertreter haben die Rücknahme grundsätzlich durch geeignete Rückgabemöglichkeiten in zumutbarer Entfernung zum jeweiligen Endnutzer zu gewährleisten. Die Möglichkeit der unentgeltlichen Rückgabe eines Altgerätes besteht bei rücknahmepflichtigen Vertreibern unter anderem dann, wenn ein neues gleichartiges Gerät, das im Wesentlichen die gleichen Funktionen erfüllt, an einen Endnutzer abgegeben wird. Wenn ein neues Gerät an einen privaten Haushalt ausgeliefert wird, kann das gleichartige Altgerät auch dort zur unentgeltlichen Abholung übergeben werden; dies gilt bei einem Vertrieb unter Verwendung von Fernkommunikationsmitteln für Geräte der Kategorien 1, 2 oder 4 gemäß § 2 Abs. 1 ElektroG, nämlich „Wärmeüberträger“, „Bildschirmgeräte“ oder „Großgeräte“ (letztere mit mindestens einer äußeren Abmessung über 50 Zentimeter). Zu einer entsprechenden Rückgabe-Absicht werden Endnutzer beim Abschluss eines Kaufvertrages befragt. Außerdem besteht die Möglichkeit der unentgeltlichen Rückgabe bei Sammelstellen der Vertreter unabhängig vom Kauf eines neuen Gerätes für solche Altgeräte, die in keiner äußeren Abmessung größer als 25 Zentimeter sind, und zwar beschränkt auf drei Altgeräte pro Gerätart.

Datenschutz-Hinweis

Altgeräte enthalten häufig sensible personenbezogene Daten. Dies gilt insbesondere für Geräte der Informations- und Telekommunikationstechnik wie Computer und Smartphones. Bitte beachten Sie in Ihrem eigenen Interesse, dass für die Löschung der Daten auf den zu entsorgenden Altgeräten jeder Endnutzer selbst verantwortlich ist.

Bedeutung des Symbols „durchgestrichene Mülltonne“

as auf Elektro- und Elektronikgeräten regelmäßig abgebildete Symbol einer durchgestrichenen Mülltonne weist darauf hin, dass das jeweilige Gerät am Ende seiner Lebensdauer getrennt vom unsortierten Siedlungsabfall zu erfassen ist.

En, wenden Sie sich für weitere Informationen bitte an Ihren Händler oder Lieferanten.

Safety instructions



WARNING:

To reduce the risk of fire or electric shock, do not expose this apparatus to rain or moisture.

Apparatus shall not be exposed to dripping or splashing area. Objects filled with liquids such as vases shall not be placed on the apparatus.

IMPORTANT SAFETY INSTRUCTIONS

1. Read these instructions.
2. Keep these instructions.
3. Heed all warnings.
4. Follow all instructions.



8. Do not install near any heat source such as radiators, heat registers, stoves, or other apparatus (including amplifiers) that produce heat.



5. Do not use this apparatus near water.



9. Unplug this apparatus during lightning storms or when unused for long period of time.



6. Clean only with a dry cloth.



10. Protect the power cord from being walked on or pinched particularly at plugs, convenience receptacles, and the point where they exit from the apparatus.



7. Do not block any of the ventilation openings. Install in accordance with the manufacturer's instructions.



11. Only use the attachments/accessories specified by the manufacturer.

12. Refer all servicing to qualified service personnel. Servicing is required when the apparatus has been damaged in any way, such as power supply cord or plug is damaged, liquid has been spilled or objects have fallen into the apparatus, the apparatus has been exposed to rain or moisture, does not operate normally, or has been dropped.



13. Use only with a cart, stand, tripod, bracket, or table specified by the manufacturer, or sold with the apparatus. When a cart is used, be cautious when moving the cart/apparatus combination to avoid injury from tip-over.



14. Do not defeat the safety purpose of the polarized or grounding type plug. A polarized plug has two blades with one wider than the other. A grounding type plug has two blades and a third grounding type plug has two blades and a third grounding prong. The wide blade or the third prong is provided for your safety. When the provided plug does not fit for your outlet, consult an electrician for replacement of the obsolete outlet.

Note

- If the CCTV monitor feel cold to the touch, there may be a small “flicker” when it is turned on. This is normal, there is nothing wrong with CCTV monitor .
- Some minute dot defects may be visible on the screen, appearing as tiny red, green, or blue spots. However there have no adverse effect on the monitor's performance.
- Avoid touching the LED screen or holding your finger(s) against it for long periods of time. In that case, it may produce some temporary distortion effect on the screen.

CAUTION connecting the Power Cord

Most appliances are suggested to be placed upon a dedicated circuit; that is a single outlet circuit which powers only that appliance and has no additional outlets or branch circuits.

Do not overload wall outlets! Overloaded wall outlets, loose or damaged wall outlets, extension cords, frayed power cords, damaged or cracked wire insulation are dangerous. Any of these conditions could result in electric shock or fire. Periodically examine the cord of your appliance, and its if appearance indicates damage or deterioration, unplug it, discontinue use of the appliance, and have the cord replaced with an exact replacement part by an authorized servicer. Protect the power cord from physical or mechanical abuse, such as being wisted, kinked, pinched, closed in a door, or wadded upon. Pay particular attention to plugs, wall outlets, and the point where the cord exits the appliance.

On Disposal

- The fluorescent lamp used in this product contain a small amount of mercury.
 - Do not dispose of this product with general household waste.
- Disposal of this product must be carried out in accordance to the regulations of your local authority.

4. Maintenance

Early malfunctions can be prevented by maintaining the monitor. Careful and regular cleaning can extend the lifetime. Be sure to turn of the power and unplug the power cord before maintaining or cleaning the monitor

Cleaning the screen

Wipe the screen with a soft, damp, lint-free cloth. Allow the screen to dry before connecting the power cable and turning on the monitor. Do not use abrasive cleaners.

Cleaning the cabinet

To remove dirt or dust, wipe the cabinet with a soft, dry, lint-free cloth. Please be sure not to use a wet cloth. Do not use abrasive cleaners.

Extended Storage



If you expect not to use your monitor for extended periods of time be sure to disconnect the monitor's power cable.

3. Trouble shooting

If any problems or issues with the monitor please consult below possible solutions before contacting the Ernitec Technical Support.

PROBLEM	POSSIBLE SOLUTION
No sound / picture	-Check all cables are connected correctly. -Check that you have pressed the POWER button on the front of monitor set. -Check the picture contrast and brightness settings.
Normal picture but no sound	-Check the volume. -Try another channel the problem may be with the broadcast. -Are the audio cables installed properly.
The remote control does not work	-Check go see if there any object between the product and remote control -Are batteries installed with correct polarity(+to+, -to-). -Install new batteries.
Power is suddenly turned off	-Is the sleep timer set. -Check the power control settings. Power interrupted. -No broadcast on station tuned with auto activated.
Picture appears slowly after switching on	-This is normal, the image is muted during the product startup process. Please contact Ernitec Support, if the picture has not appeared after five minutes.
No or poor color or poor picture	-Adjust the color in menu option. -Keep a sufficient distance between the product and the VCR. -Try another channel, the problem may be with the broadcast. -Are the VIDEO cables installed properly?
Horizontal/vertical bars or picture shaking	-Check for local interference such as an electrical appliance or power tool.
No output from one of the speakers	-Adjust balance in menu option.

NOTE: Problem and possible solution (only applies to VGA mode)

PROBLEM	POSSIBLE SOLUTION
The signal is out of range	-Adjust resolution, horizontal frequency, or vertical frequency. -Check it whether the signal cable is connected or loose. -Check the input source.
Vertical bar or stripe on back ground & Horizontal Noise & Incorrect position	-Work the auto configure or adjust clock, phase, or H/V position.
Screen color is unstable or single color	-Check the signal cable. -Reinstall the PC video card.

1. Introduction

1.1 Accessories

Ensure that the following accessories are included with your CCTV monitor. If any accessory is missing, please contact the dealer from where you purchased the product.



Power Cord



Power Supply



User Manual



Remote control

1.2 Remote Control Key Functions



POWER
Switch on monitor when at standby mode or vice versa.

MUTE
Press to mute the sound. Press again or press VOL+ to unmute.

▲
▼
Menu selection. ▼ ▲

▶
◀
Press to increase / decrease

MENU
Press to bring up the main menu to the screen and exit the current menu.

INPUT
Press to cycle through the input source in Following:
VGA BNC HDMI 1 / HDMI 2

PICTURE
Press repeatedly to cycle through the available video picture

1.3 Installing batteries in remote control

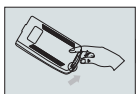

Open the battery compartment cover on the the back side.

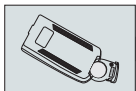

Insert ONE CR2032 3V batteries in correct polarity .Do not mix old or used batteries with new ones.

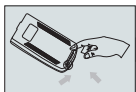

Close the cover.



Point the remote towards the remote control sensor of the monitor and use it within 7 meters.

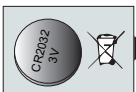

Dispose used batteries at designated collection points. Do not mix used batteries with general household waste.

1.4 Connection options

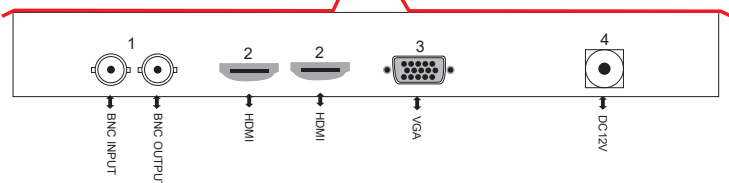
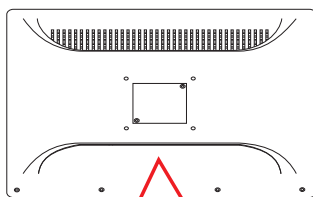

ITEM	BUTTON NAME	FUNCTION DESCRIPTION
1	BNC	TVI/CVI/AHD/CVBS INPUT/OUTPUT
2	HDMI	2pcs HDMI INPUT
3	VGA	VGA INPUT
4	POWER	12V Input

2.5.5 User Reset Options

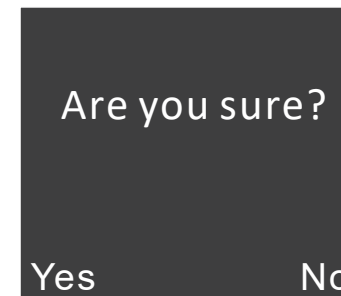
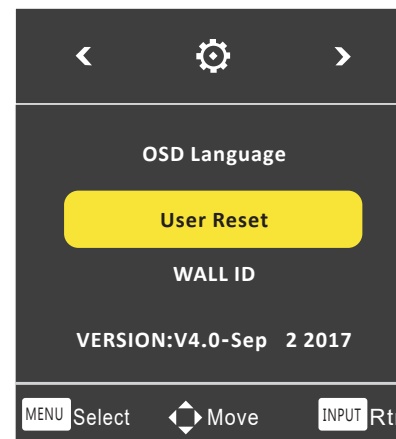

- Press “ < > ”button to select User Reset menu.
- Use “ ▼ ▲ ” to select what you want to adjust
- Press “ < > ”button to adjust.
- When you are satisfied with your adjustment, press “Yes” or “No” to confirm

2.5.3 Aspect Ratio options

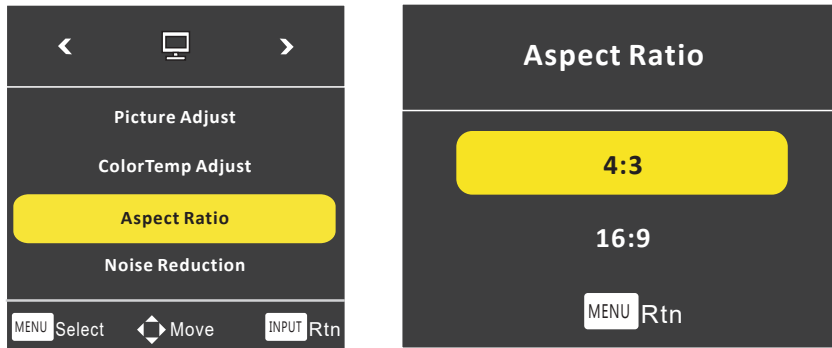

- Press “◀ ▶”button to select Aspect Ratio menu.
- Use “▼▲” to select what you want to adjust in the HDMI/VGA mode.
- Press “◀ ▶”button to adjust.
- When you are satisfied with your adjustment, press MENU to exit the main menu.

2.5.4 Noise Reduction options

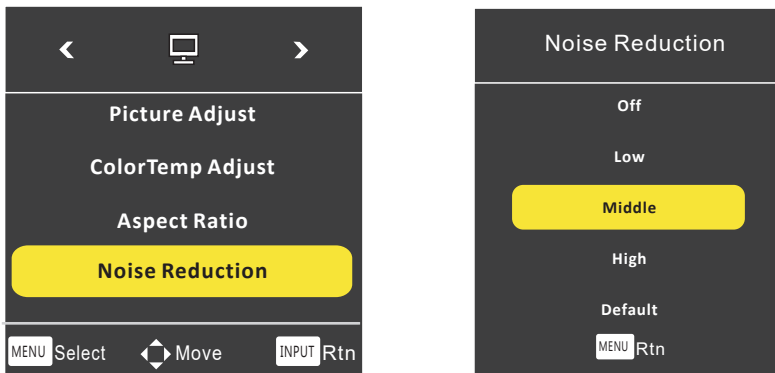

- Press “◀ ▶”button to select Noise Reduction menu.
- Use “▼▲” to select what you want to adjust
- When you are satisfied with your adjustment, press MENU to exit the main menu.

1.5 External Equipment Connections

This CCTV monitor provides plug and play capability, meaning that the PC adjusts automatically to the monitor's setting. The CCTV monitor sends configuration information (EDID) to the PC using the Video Electronics Standard Association (VESA) Display Data Channel (DDC) protocol.

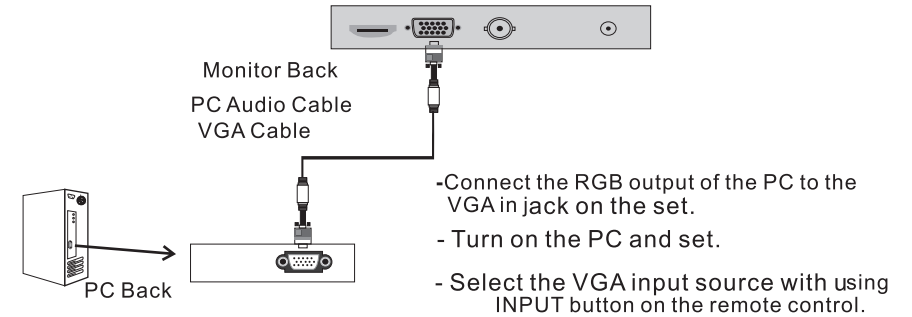

2. Basic OSD setup

2.1 Turning on and off the CCTV monitor

2.1.1 Turn on Monitor

- Connect the AC input cable to monitor, then press the main power switch on monitor. At this time the monitor will enter into standby mode and the indicator light turn red.
- Using buttons can turn on monitor from standby mode as follows:
Press POWER key on front panel or on the remote control.

2.1.2 Turn off Monitor

- Press POWER button on front panel the or on the remote control to enter standby mode. The indicator light is red.
- Using main power switch turns off monitor completely.

2.2 Selecting screen language

NOTE: If you use your monitor for the first time, you should select the language which will be used for displaying menus and indications.



- Press the “MENU” button into main menu.
- Press the “◀ ▶” button to select OSD menu.
- Press the “▼▲” button to select OSD LANGUAGE.
- Press the “◀ ▶” button to select your language.
- When you are satisfied with your choice, press MENU to exit.

2.3 NO SIGNAL

“No Signal” will be displayed on the screen when there is no input signal.

NO SIGNAL

2.4 Selecting input source

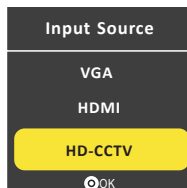

You can select the input source by pressing INPUT button on the remote control on the front panel.

- Press the “▼▲” button to select the source you want.
- Press the “INPUT” button to confirm.

2.5 OSD Settings (VGA/HDMI mode)

- Press the “MENU” button to access Main Menu setting interface.
- Press the “◀ ▶” to select the desired submenu.
- Press the “▼▲” again to enter the submenu.

2.5.1 Picture Adjustment Options

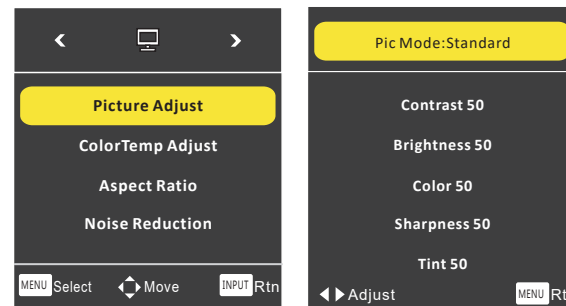

- Press “◀ ▶” button to select “Picture Adjust” menu.
- Use “▼▲” to select what you want to adjust in the VGA/HDMI mode.
- Press “◀ ▶” button to adjust.
- When you are satisfied with your adjustment, press MENU to exit the main menu.

2.5.2 Color Temperature Adjust Options

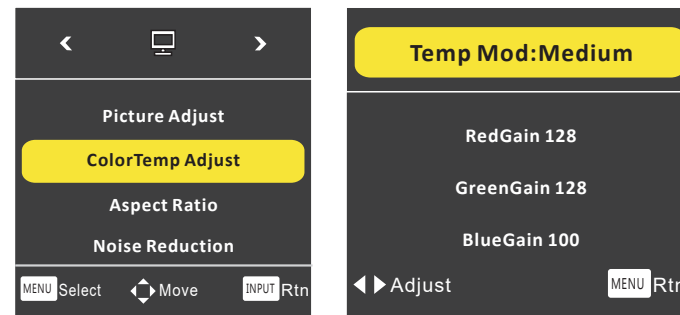

- Press “◀ ▶” button to select ColorTemp Adjust menu.
- Use “▼▲” to select what you want to adjust in the VGA/HDMI mode.
- Press “◀ ▶” button to adjust.
- When you are satisfied with your adjustment, press MENU to exit the main menu.